



TIG056BF

N-Channel IGBT

430V, 240A, VCE(sat); 3.6V TO-220F-3FS

ON Semiconductor®

<http://onsemi.com>

Features

- Low-saturation voltage
- Ultrahigh speed switching
- Enhancement type
- Protection diode in

Specifications

Absolute Maximum Ratings at Ta=25°C

Parameter	Symbol	Conditions	Ratings	Unit
Collector to Emitter Voltage	V _{CES}		430	V
Gate to Emitter Voltage	V _{GES}		±33	V
Collector Current (Pulse)	I _{CP}	V _{GE} =15V, C _M =2000µF	240	A
Allowable Power Dissipation	P _D	T _c =25°C	30	W
Channel Temperature	T _{ch}		150	°C
Storage Temperature	T _{stg}		-55 to +150	°C

Stresses exceeding Maximum Ratings may damage the device. Maximum Ratings are stress ratings only. Functional operation above the Recommended Operating Conditions is not implied. Extended exposure to stresses above the Recommended Operating Conditions may affect device reliability.

Package Dimensions

unit : mm (typ)

7528-002

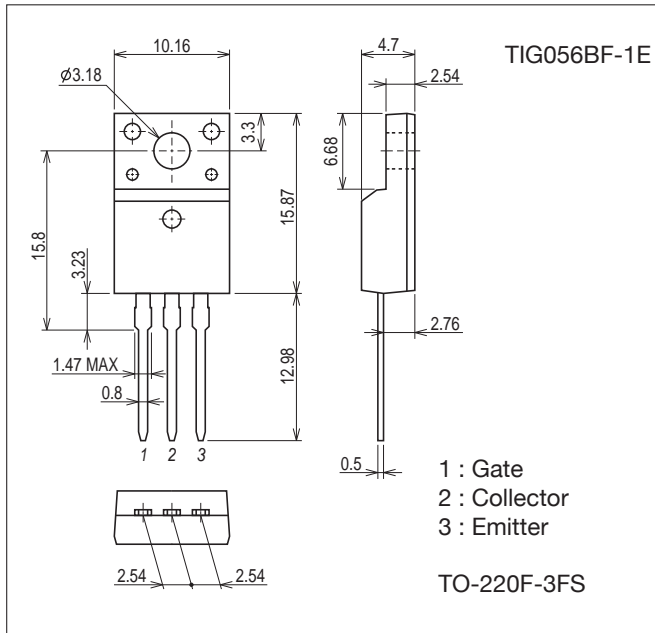

Ordering & Package Information

Device	Package	Shipping	memo
TIG056BF-1E	TO-220F-3FS SC-67	50 pcs./magazine	Pb-Free

Marking

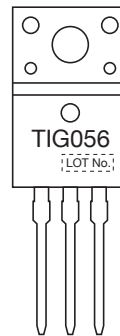

Electrical Connection

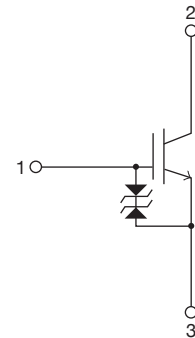

TIG056BF

Electrical Characteristics at $T_a=25^\circ\text{C}$

Parameter	Symbol	Conditions	Ratings			Unit	
			min	typ	max		
Collector to Emitter Breakdown Voltage	$V_{(BR)CES}$	$I_C=2\text{mA}, V_{GE}=0\text{V}$	430			V	
Collector to Emitter Cutoff Current	I_{CES}	$V_{CE}=320\text{V}, V_{GE}=0\text{V}$			100	μA	
Gate to Emitter Leakage Current	I_{GES}	$V_{GE}=\pm 30\text{V}, V_{CE}=0\text{V}$			± 10	μA	
Gate to Emitter Threshold Voltage	$V_{GE(\text{off})}$	$V_{CE}=10\text{V}, I_C=1\text{mA}$	2.5		5.0	V	
Collector to Emitter Saturation Voltage	$V_{CE(\text{sat})}$	$I_C=240\text{A}, V_{GE}=15\text{V}$		3.6	5.0	V	
Input Capacitance	C_{ies}	$V_{CE}=20\text{V}, f=1\text{MHz}$		5500		pF	
Output Capacitance	C_{oes}				100		pF
Reverse Transfer Capacitance	C_{res}				70		pF
Turn-ON Delay Time	$t_{d(\text{on})}$				46		ns
Rise Time	t_r	$V_{CE}=320\text{V}, I_C=240\text{A}, V_{GE}=15\text{V}, R_G=10\Omega$			32		ns
Turn-OFF Delay Time	$t_{d(\text{off})}$				140		ns
Fall Time	t_f				270		ns

Fig1 Large Current R Load Switching Circuit

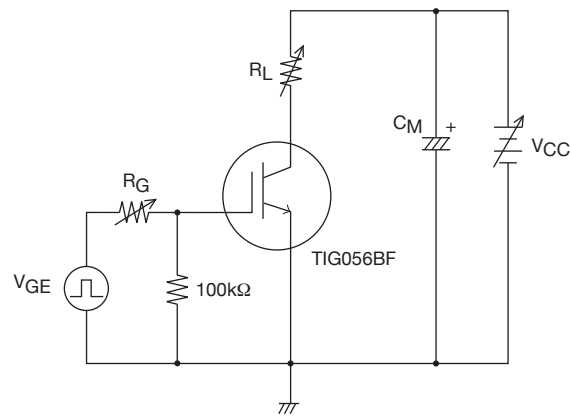

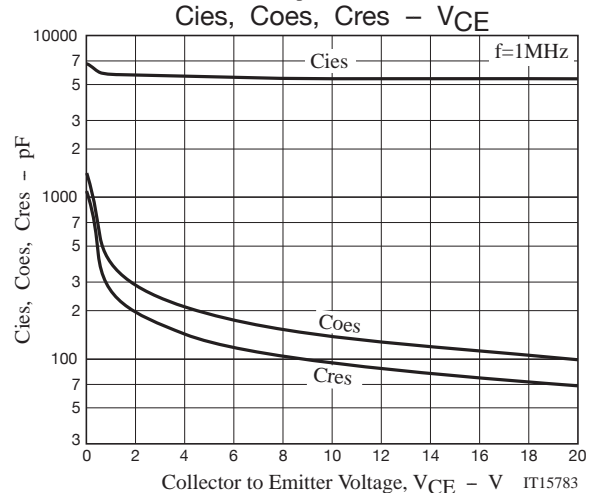
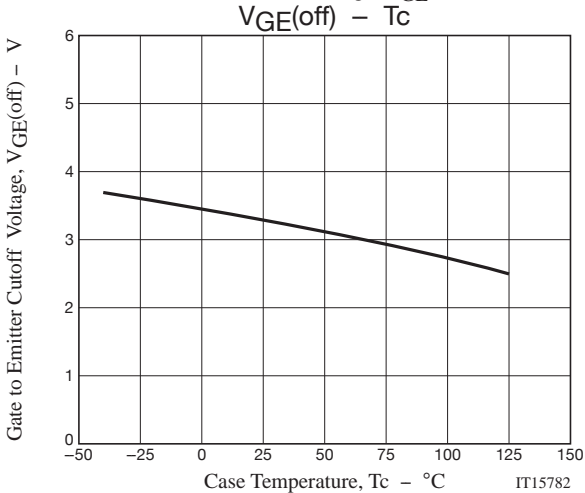
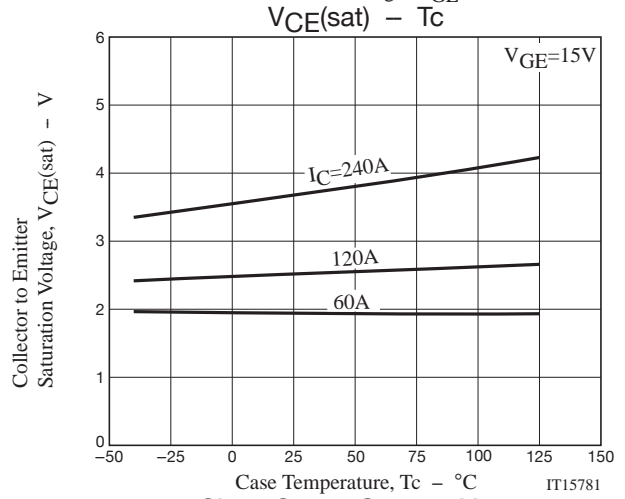
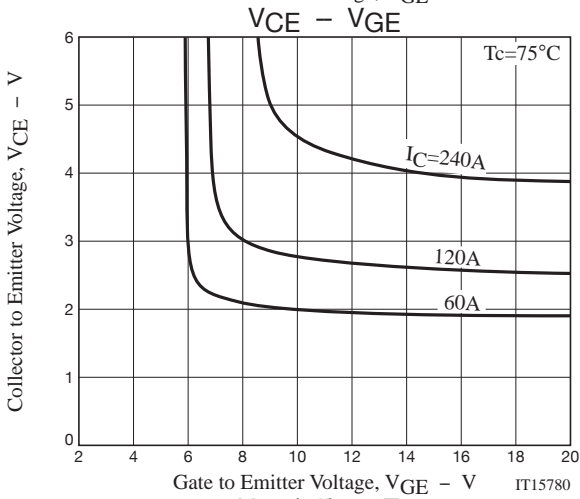
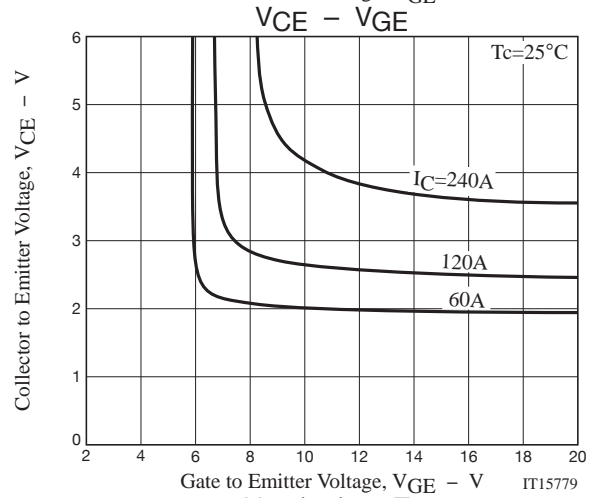
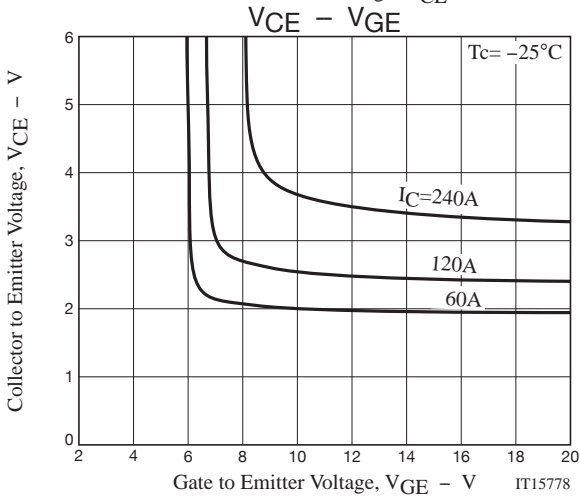
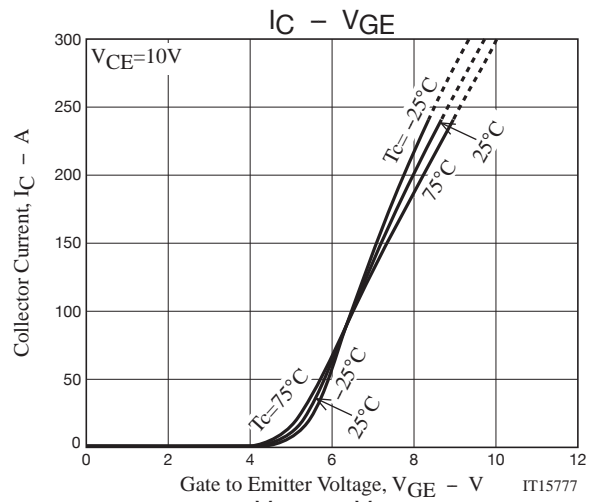
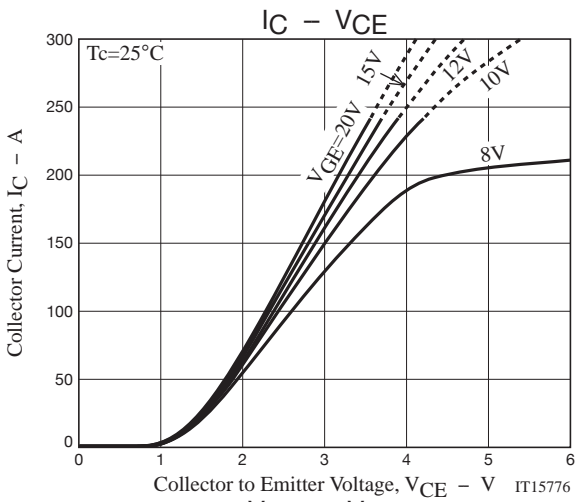

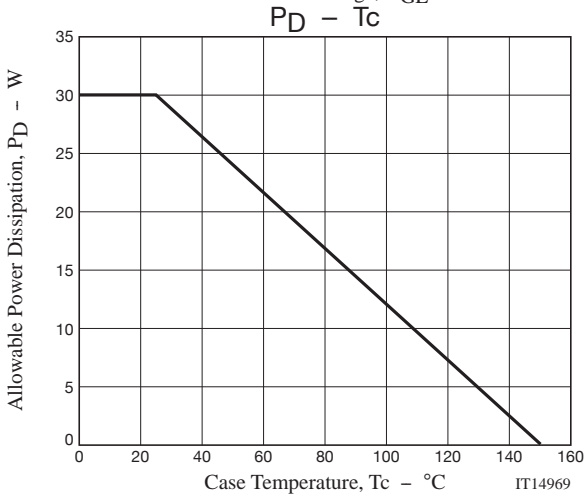
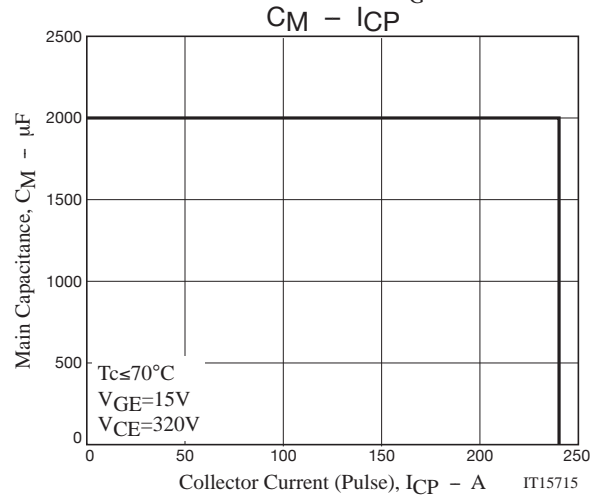
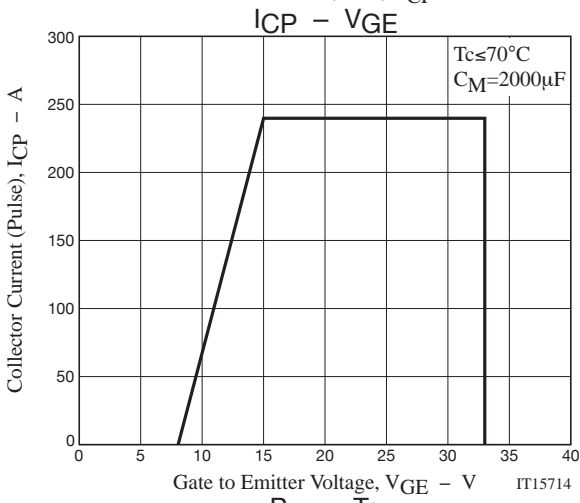
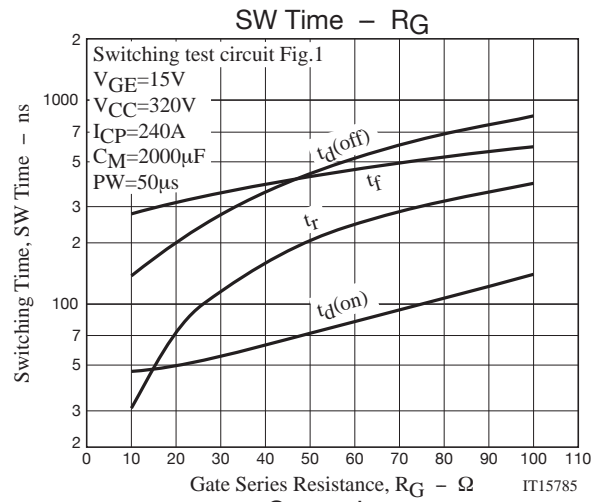
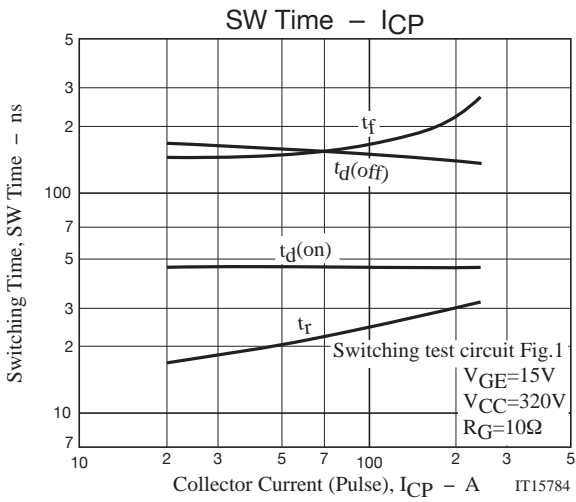

TIG056BF

Outline Drawing

TIG056BF-1E

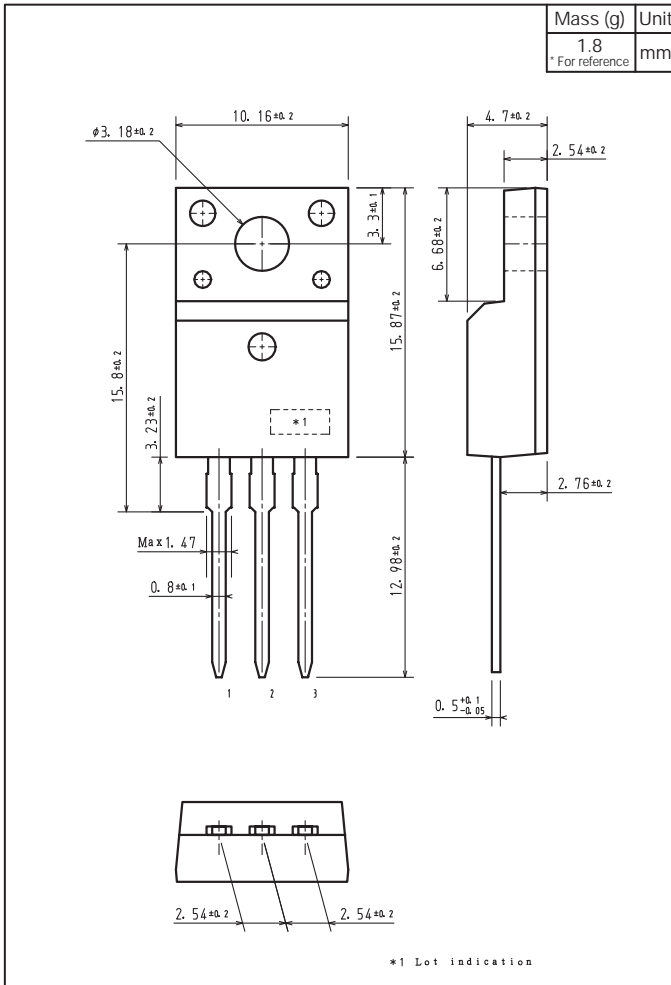

Note on usage : TIG056BF has protection diode between gate and emitter but handling it requires sufficient care to be taken.

ON Semiconductor and the ON logo are registered trademarks of Semiconductor Components Industries, LLC (SCILLC). SCILLC owns the rights to a number of patents, trademarks, copyrights, trade secrets, and other intellectual property. A listing of SCILLC's product/patent coverage may be accessed at www.onsemi.com/site/pdf/Patent-Marking.pdf. SCILLC reserves the right to make changes without further notice to any products herein. SCILLC makes no warranty, representation or guarantee regarding the suitability of its products for any particular purpose, nor does SCILLC assume any liability arising out of the application or use of any product or circuit, and specifically disclaims any and all liability, including without limitation special, consequential or incidental damages. "Typical" parameters which may be provided in SCILLC data sheets and/or specifications can and do vary in different applications and actual performance may vary over time. All operating parameters, including "Typicals" must be validated for each customer application by customer's technical experts. SCILLC does not convey any license under its patent rights nor the rights of others. SCILLC products are not designed, intended, or authorized for use as components in systems intended for surgical implant into the body, or other applications intended to support or sustain life, or for any other application in which the failure of the SCILLC product could create a situation where personal injury or death may occur. Should Buyer purchase or use SCILLC products for any such unintended or unauthorized application, Buyer shall indemnify and hold SCILLC and its officers, employees, subsidiaries, affiliates, and distributors harmless against all claims, costs, damages, and expenses, and reasonable attorney fees arising out of, directly or indirectly, any claim of personal injury or death associated with such unintended or unauthorized use, even if such claim alleges that SCILLC was negligent regarding the design or manufacture of the part. SCILLC is an Equal Opportunity/Affirmative Action Employer. This literature is subject to all applicable copyright laws and is not for resale in any manner.